

MONTÁŽNÍ NÁVOD
MOUNTING INSTRUCTION

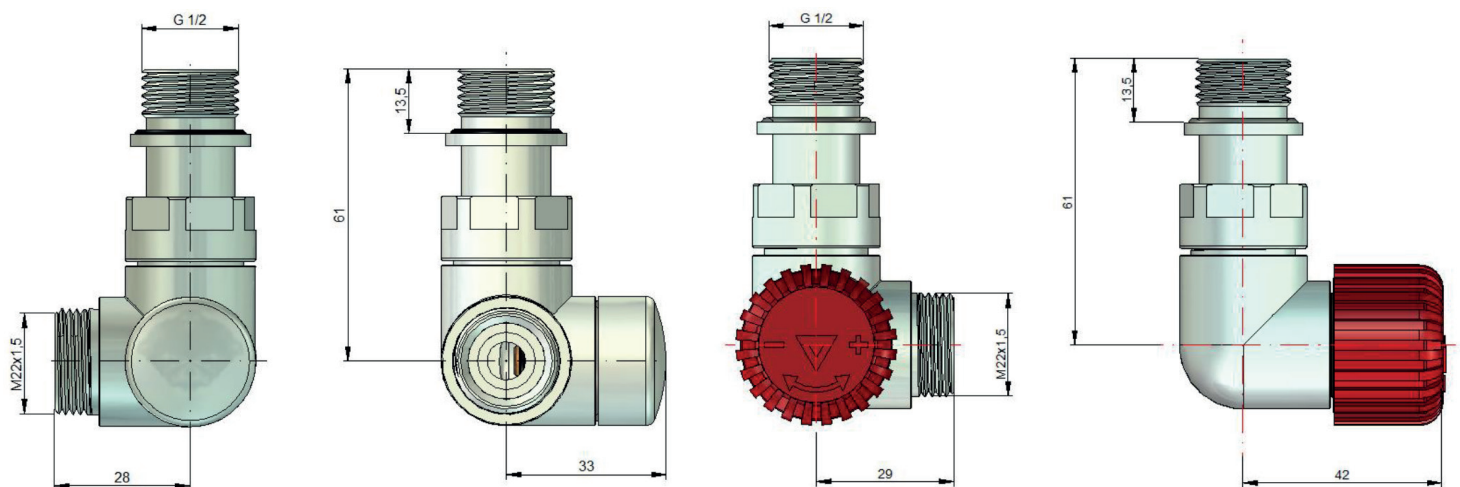



Termostatická sada „Vision“, axiální, levá nebo pravá, GZ ½" / GZ M22x1,5.

Sada obsahuje: termostatický ventil "Vision", uzavírací ventil "Vision", termostatickou hlavici .

„Vision“ thermostatic set, axial, left or right, GZ ½" / GZ M22x1.5.

The set includes: „Vision“ thermostatic valve, „Vision“ shut-off valve, thermo-static head.

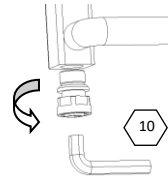
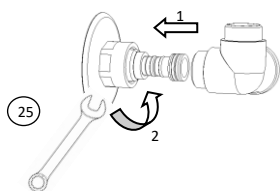
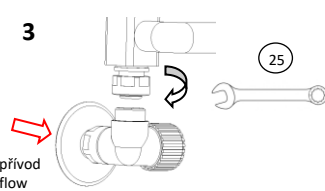
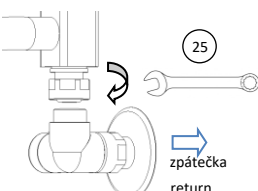
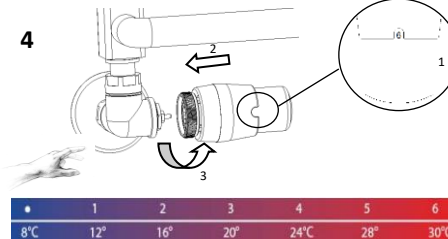
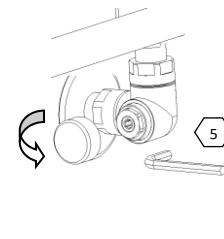
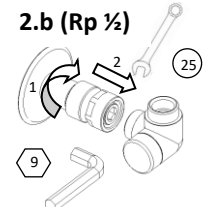
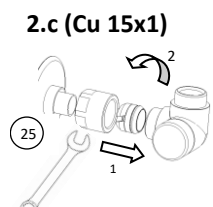
<p>1</p> 	<p>Dávejte pozor, abyste při utahování nepoškodili o-kroužek, který je zodpovědný za těsnost</p> <p><i>Make sure not to damage the o-ring, which is responsible for the tightness between the radiator and the fitting, when tightening it.</i></p>														
<p>2.a (PEX 16x2)</p> 	<p>Při montáži šroubení 16x2 dávejte pozor abyste nepoškodili o-kroužky, které jsou zodpovědné za těsnost šroubení .</p> <p><i>You must know that during the assembly of the 16x2 fitting you do not damage the o-rings, which are responsible for the tightness of the fitting between the installation and the valve.</i></p>														
<p>3</p>  <p>přívod flow</p>	<p>3</p>  <p>zpátečka return</p>														
<p>4</p>  <table border="1" data-bbox="100 957 548 1005"> <tr> <td>•</td> <td>1</td> <td>2</td> <td>3</td> <td>4</td> <td>5</td> <td>6</td> </tr> <tr> <td></td> <td>8°C</td> <td>12°</td> <td>16°</td> <td>20°</td> <td>24°C</td> <td>30°C</td> </tr> </table>	•	1	2	3	4	5	6		8°C	12°	16°	20°	24°C	30°C	<p>4</p> 
•	1	2	3	4	5	6									
	8°C	12°	16°	20°	24°C	30°C									
<p>2.b (Rp ½)</p> 	<p>2.c (Cu 15x1)</p> 														

Záruční podmínky/ Terms of warranty:

- Výrobce poskytuje záruku po dobu 2 let od data nákupu.
- Oznámení o závadě nebo poškození přijímáme e-malem:
- Pro provedení záruční opravy je třeba vadný výrobek doručit na adresu:
- Záruka se nevztahuje na díly, které během své životnosti podléhají přirozenému opotřebení a na vady vzniklé v důsledku instalace a používání v rozporu s návodem, na vady nesoucí známky mechanického nebo tepelného poškození nebo známky zásahu uživatele.
- Kupující ztrácí veškerá práva vyplývající ze záruky v případě: 1) ztráty nebo zničení dokladu o koupi, 2) neoprávněné opravy, demontáže, 3) nevhodného nebo v rozporu s návodem použití.
- The manufacturer provides a warranty for a period of 2 years from the date of purchase.
- In order to perform a warranty repair, the defective product must be delivered to the office with a description of the reason complaints and a copy of the proof of purchase with the stamp of the facility where the purchase was made and clearly marked with the date of purchase.
- The warranty does not cover parts that are subject to natural wear and tear during their lifetime, and defects caused as a result installation and use inconsistent with the instructions, defects bearing signs of mechanical or thermal damage or signs of user interference.
- The Purchaser loses all rights resulting from the guarantee in the event of: 1) loss or destruction of the proof of purchase, 2) unauthorized repairs, disassembly, 3) improper or inconsistent with the instructions for use.